



The **Enclosed CBQ** series provides up to 125W/25A outputs with six-sides metal package. The efficient SR stage is combined with patented “Buck Reset” topology that would reduce power loss to achieve 101W/in³ power density. The multi-layer single side circuit board design would enhance the thermal performance and improve its reliability. Modules are designed for Telecom, Servers, Networking equipments and other applications that use a 24V or 48V input bus.

PART NUMBER SYSTEM

CBQ100	48S	5V0	-L	a	b	c	XX	X
Series Name	Input Voltage	Output Voltage		Enable Logic	Pin Dimension	Base-Plate	Suffix	Version
CBQ100	48S=36V~75V 24S=18V~36V	Unit: 0.1V Increments 050=5V 033=3.3V	-L	P: Positive N: Negative	0 : 0.12" 1 : 0.16" 2 : 0.20" 3 : 0.24"	E : Metallic enclosure (1.0mm Metal Plate)	For marketing purpose only	

MODEL LIST (Contact to factory for special input / output)

Part Number *	Maximum Input	Maximum Output	Efficiency	Part Number *	Maximum Input	Maximum Output	Efficiency
CBQ10048S5V0-LabcXXX	36V~75V	139W	5.0V/25A 125W 90%	CBQ10024S5V0-LabcXXX	18V~36V	141W 5.0V/25A 125W	89%
CBQ10048S3V3-LabcXXX	36V~75V	94W	3.3V/25A 83W 89%	CBQ10024S3V3-LabcXXX	18V~36V	94W 3.3V/25A 83W	88%
CBQ10048S2V5-LabcXXX	36V~75V	73W	2.5V/25A 63W 87%	CBQ10024S2V5-LabcXXX	18V~36V	74W 2.5V/25A 63W	86%
CBQ10048S2V0-LabcXXX	36V~75V	59W	2.0V/25A 50W 85%	CBQ10024S2V0-LabcXXX	18V~36V	59W 2.0V/25A 50W	85%
CBQ10048S1V8-LabcXXX	36V~75V	53W	1.8V/25A 45W 85%	CBQ10024S1V8-LabcXXX	18V~36V	54W 1.8V/25A 45W	84%
CBQ10048S1V5-LabcXXX	36V~75V	46W	1.5V/25A 38W 83%	CBQ10024S1V5-LabcXXX	18V~36V	46W 1.5V/25A 38W	83%

REFERENCED THERMAL IMAGES

To be updated in next version	To be updated in next version

SPECIFICATIONS

Absolute Maximum Ratings		
Temperature	Operation Storage	-40°C to +110°C -55°C to +125°C
Input Voltage Range	Operation: 24V Models 48V Models Transient (100mS): 24V Models 48V Models	-0.5V to +40Vdc -0.5V to +80Vdc 50V Maximum 100V Maximum
Isolation Voltage	Input to Output Input to Case Output to Case	2.0KV Minimum 1.0KV Minimum 1.0KV Minimum
Remote Control		-0.5V to +12Vdc

General Parameters

Conversion Efficiency	Typical	See table
Switching Frequency	Typical	330KHz
MTBF	Bellcore TR-332 issue 6	4.57×10^6 hrs @GB/25°C (CBQ10048S5V0-LabcXXX)
OTP	Internal	110°C(Tc) ±5°C
Weight	Metallic enclosure	55g

Control Functions

Remote Control	Logic High Logic Low	+3.0V to +6.5V 0V to +1.0V
Input Current of Remote Control Pin		-0.5mA ~ +1.5mA

Input

Operation Voltage Range	24V Models 48V Models	+18V to +36Vdc +36V to +75Vdc
Reflected Ripple Current	$L_{EXT} = 10\mu H$	20mA rms/60mAp-p
Power ON Voltage Ranges	24V Models 48V Models	+17.0V to +18.0Vdc +34.0V to +36.0Vdc
Power OFF Voltage Ranges	24V Models 48V Models	+15.6V to +16.6Vdc +31.2V to +33.2Vdc
Off State Input Current	V_{NOM}	6mA Max
Latch-State Input Current	V_{NOM}	8mA Max
Input Capacitance	24V Models 48V Models	22.0uF Max 10.0uF Max

Output

Voltage Accuracy	Typical	±1.0%
Line Regulation	Full Input Range	±0.3%
Load Regulation	0%~100%	±0.3%
Temperature Drift	-40°C ~100°C	±0.03%/°C
Output Tolerance Band	All Conditions	±4%
Ripple & Noise (20MHz)	Peak-Peak (RMS)	3% (1%) V_O
Over Voltage Protection	V_{NOM} , 10% Load	115~130 % V_O
Output Current Limits	V_{NOM}	108%~125%
Voltage Trim	V_{NOM} , 10% Load	±10%
Input Ripple Rejection (<1KHz)	V_{NOM} , Full Load	-50dB
Step Load (2.5A/μS)	50%~75% Load	±6% V_O /500μS
Start-Up Delay Time	V_{NOM} , Full Load	20mS/250mS

TYPICAL WAVES AND CURVES

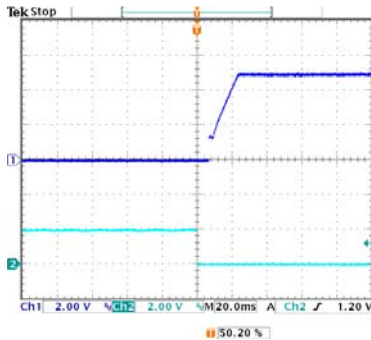

Start-up waveform of CBQ10048S5V0-LabcXXX
(V_{IN} : 48V, Load: 25A)

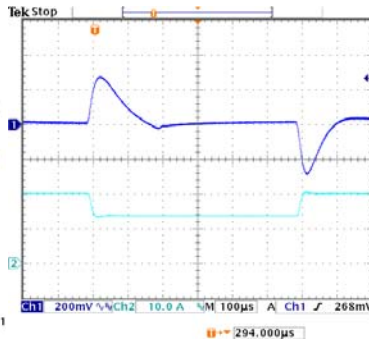

Transient response of CBQ10048S5V0-LabcXXX
(V_{IN} : 48V, Load: 20.5A/13.0A@2.5A/ μ S)

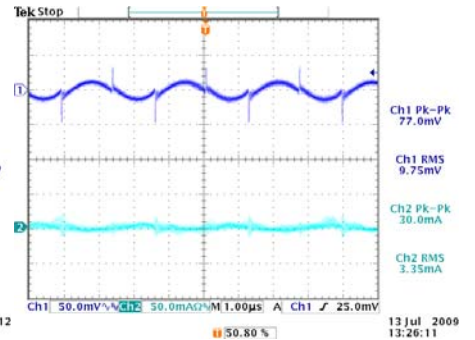

Input/Output ripples of CBQ10048S5V0-LabcXXX
(V_{IN} : 48V, Load: 25A, L_{IN} =10uH, C_{IN} =100uH)

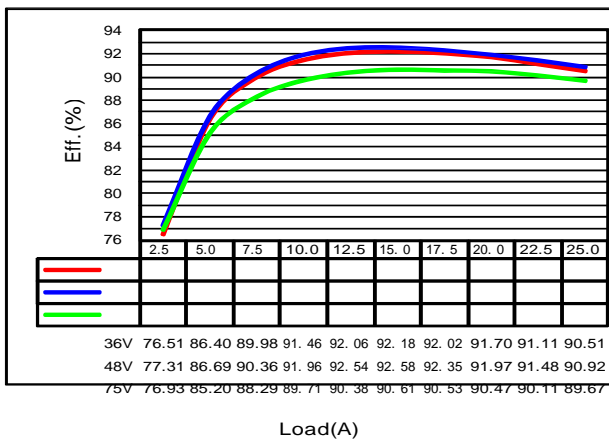

Efficiency plot of CBQ10048S5V0-LabcXXX

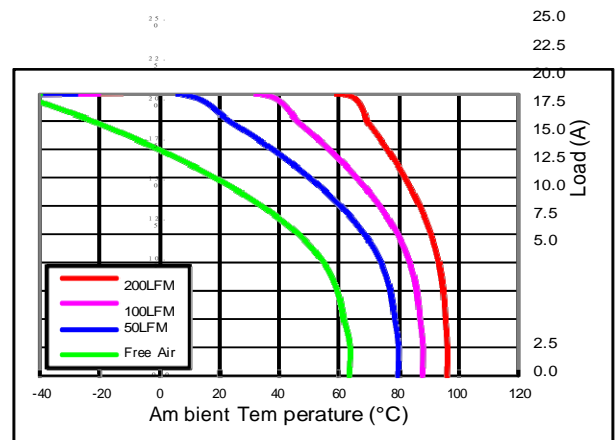

Derating curves of CBQ10048S5V0-LabcXXX for $T_c = 110^\circ\text{C}$

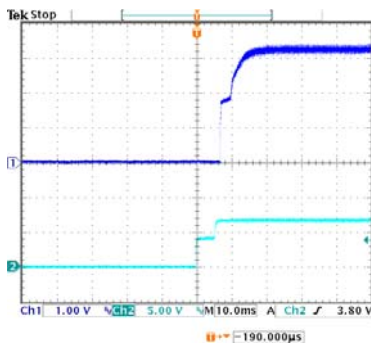

Start-up waveform of CBQ10024S3V3-LabcXXX
(V_{IN} : 24V, Load: 25A)

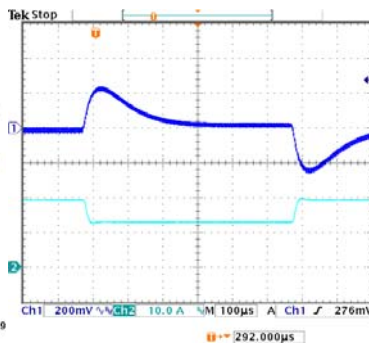

Transient response of CBQ10024S3V3-LabcXXX
(V_{IN} : 24V, Load: 20A/12.5A@2.5A/ μ S)

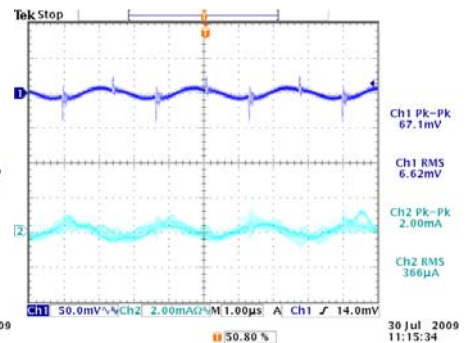

Input/Output ripples of CBQ10024S3V3-LabcXXX
(V_{IN} : 24V, Load: 25A, L_{IN} =10uH)

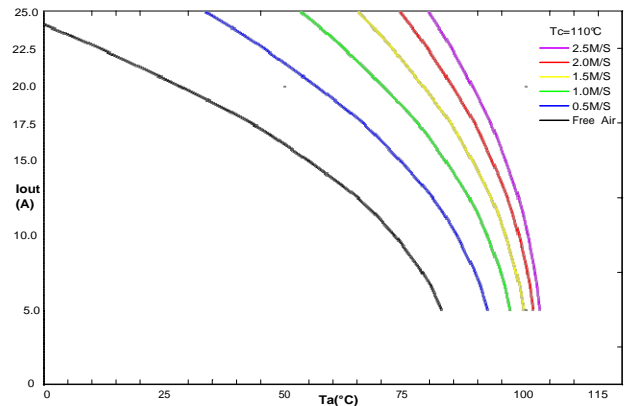
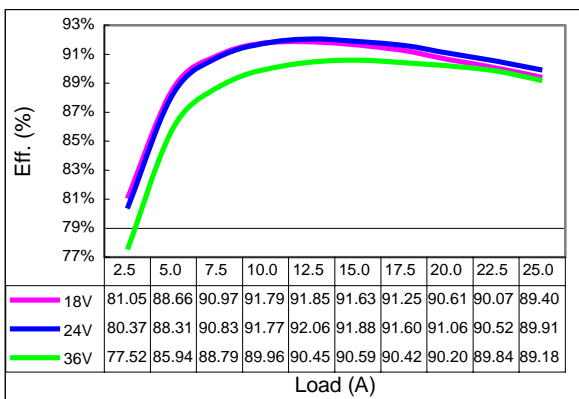

METAL ENCLOSED PACKAGE

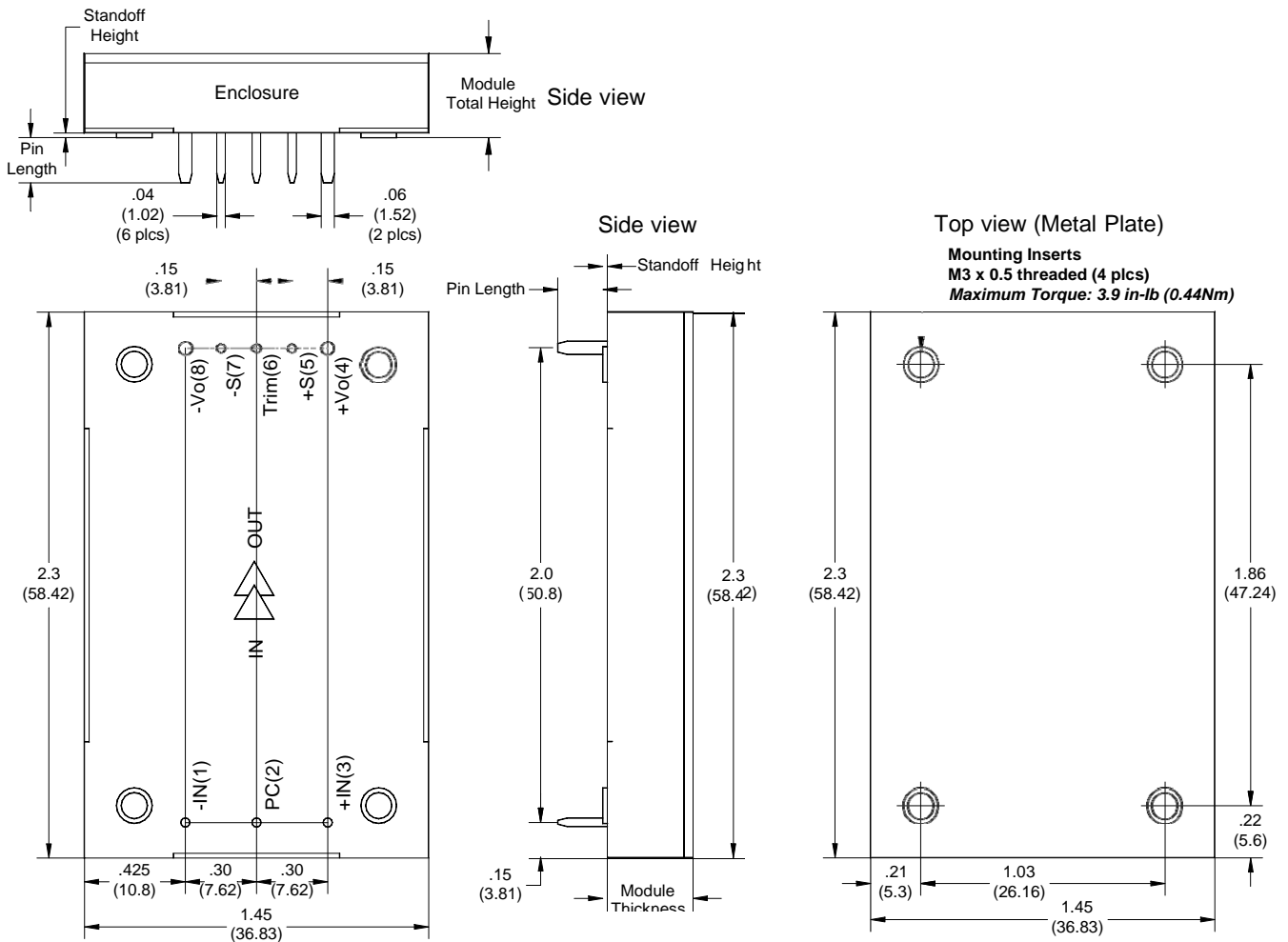

Dimensions and Pin Connections

Designation	Function Description	Pin #
-IN	Negative input	1
PC	Remote control. To turn-on and turn-off output.	2
+IN	Positive input	3
+Vo	Positive output	4
+S	Positive remote sense	5
TRIM	Output voltage adjust	6
-S	Negative remote sense	7
-Vo	Negative output	8

Dimensions: inches (mm)
Tolerances: .xx±0.02 (.x±0.5)
 .xxx±0.01 (.x±0.25)
Weight: 55g
Base plate: Aluminum alloy with anode oxide
Mounting inserts: Stainless steel
Maximum torque: 3.9 in-lb (0.44Nm)
Pin material: Copper alloy or Brass
Pin plating: Golden over Nickel

REFERENCED EMC CIRCUIT

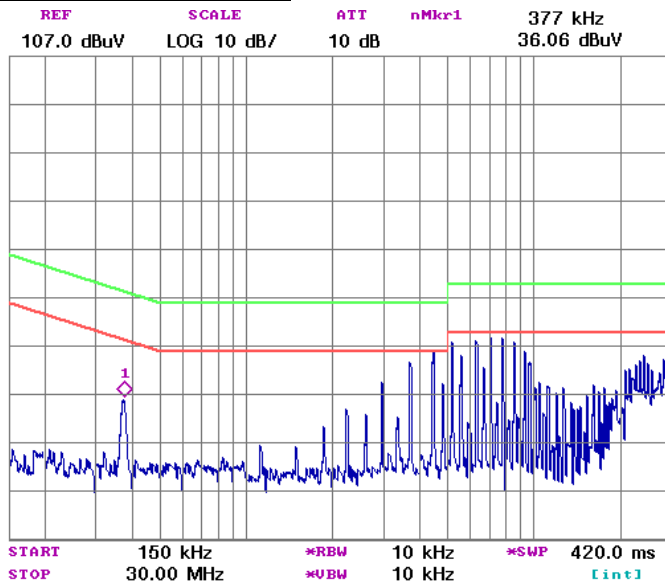

Referenced EMC Performance

The tested result shown in left-hand side is obtained by loading the power module with a resistive load only. It can be used as a design reference for customer system. However! The performance of customer's system depends on the whole system design. It should be noted that modifications on the circuit parameters and fine adjustment of the final layout affect the final EMC performance greatly.

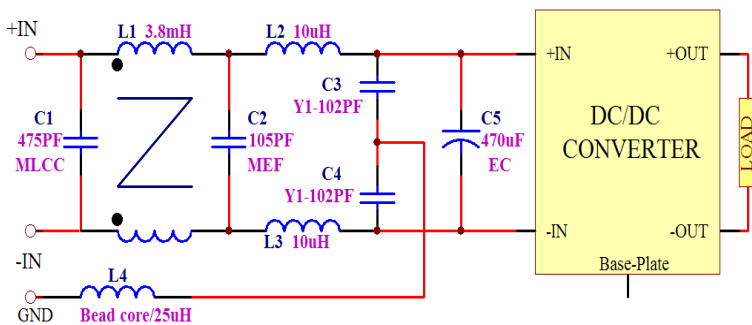

Measured conductive level of CBQ10048S5V0-LabcXXX and referenced filter circuit

Bandwidth of EMC Components

No components are ideal for infinite frequency range. The bandwidth of EMC components should be taking into consideration when designing an EMC filter circuit. To connect ceramic capacitor with electricity capacitor in parallel and connect low inductance inductor with big one could get a better bandwidth.

NOTE:

1. It is recommended that the input should be protected by fuses or other protection devices.
2. All specifications are typical at nominal input, full load and 25°C unless otherwise noted.
3. Specifications are subject to change without notice.
4. Printed or downloaded datasheets are not subject to Glary document control.
5. Product labels shown, including safety agency certificates, may vary based on the date of manufacture.
6. Information provided in this documentation is for ordering purposes only.
7. This product is not designed for use in critical life support systems, equipment used in hazardous environments, nuclear control systems or other such applications, which necessitate specific safety and regulatory standards other than the ones listed in this datasheet.

IMPORTANT

- ※ General specifications and the performances are related to standard series only, no special customer specification display here except requested items.
- ※ In order to secure effective usage of converter and the validity of Glary's service and warranty coverage, please refer to the application notes for general usage. For needs of usage beyond the application notes, please contact to Glary headquarter or our regional sales representative office for help.