

The **COQ** series provides up to 175W/50A outputs with industry standard quarter brick pin assignment. The efficient SR stage is combined with patented "Buck Reset" topology that would reduce power loss to achieve 145W/in³ power density. The multi-layer single side circuit board design plus the Sink-plate technology would enhance the thermal performance and improve its reliability. Modules are designed for Telecom, Servers, Networking equipments and other applications that use a 24V or 48V input bus.

PART NUMBER SYSTEM

COQ	48	120	a	b	c	d	-	14	XX	X
Series Name	Input Voltage	Output Voltage	Enable Logic	Pin Dimension	Standoff Height	Base-Plate		Output Current	Suffix	Version
COQ	48=36V~75V 24=18V~36V	Unit: 0.1V Increments 120=12V 050=5V	P: Positive N: Negative	0 : 0.12" 1 : 0.16" 2 : 0.20" 3 : 0.24"	0 : 0.02" 1 : 0.08" 2 : 0.16"	M : 1.0mm metal plate S : 3.0mm metal plate A : 3.0mm sink-plate B : 5.0mm sink-plate		00~50 : For output current rating	For marketing purpose only	

MODEL LIST (Contact to factory for special input / output)

Part Number *	Maximum Input	Maximum Output	Efficiency	Part Number *	Maximum Input	Maximum Output	Efficiency
COQ48120abcd-14XXX	36V~75V 184W	12.0V/14A 168W	91%	COQ24120abcd-12XXX	18V~36V 160W	12.0V/12A 144W	91%
COQ48070abcd-21XXX	36V~75V 163W	7.0V/21A 147W	90%	COQ24050abcd-30XXX	18V~36V 168W	5.0V/30A 150W	90%
COQ48050abcd-35XXX	36V~75V 195W	5.0V/35A 175W	90%	COQ24033abcd-35XXX	18V~36V 131W	3.3V/35A 116W	89%
COQ48033abcd-35XXX	36V~75V 131W	3.3V/35A 116W	89%	COQ24025abcd-40XXX	18V~36V 146W	2.5V/40A 100W	86%
COQ48025abcd-50XXX	36V~75V 146W	2.5V/50A 125W	86%	COQ24018abcd-50XXX	18V~36V 106W	1.8V/50A 90W	86%
COQ48018abcd-50XXX	36V~75V 106W	1.8V/50A 90W	86%	COQ24015abcd-50XXX	18V~36V 90W	1.5V/50A 75W	84%
COQ48015abcd-50XXX	36V~75V 90W	1.5V/50A 75W	84%				

REFERENCED THERMAL IMAGES

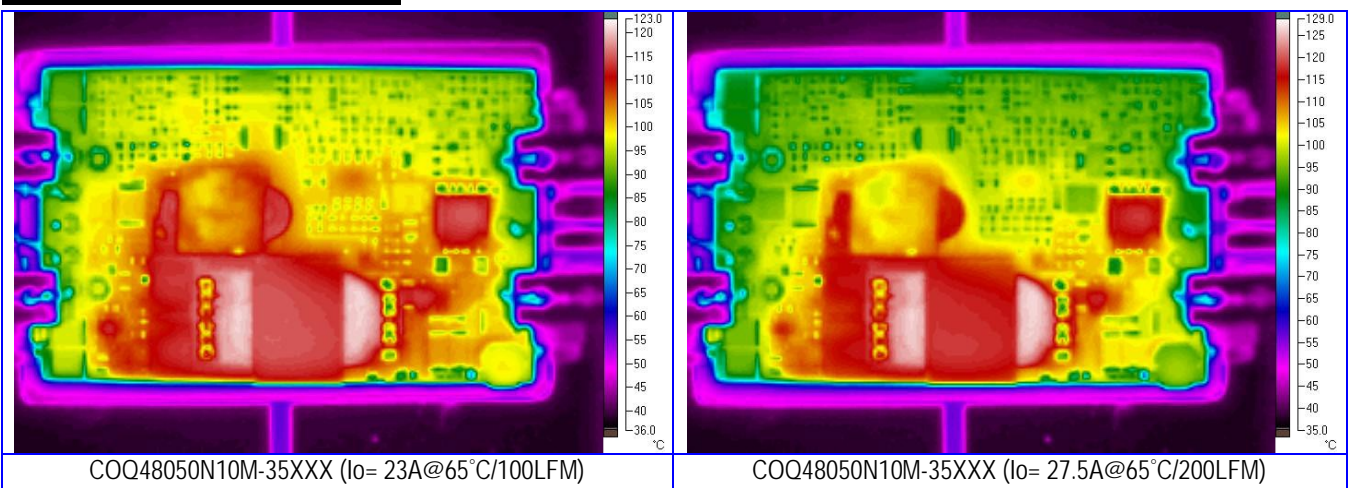

SPECIFICATIONS**Absolute Maximum Ratings**

Temperature	Operation Storage	-40°C to +110°C -55°C to +125°C
Input Voltage Range	Operation: 24V Models 48V Models Transient (100mS): 24V Models 48V Models	-0.5V to +40Vdc -0.5V to +80Vdc 50V Maximum 100V Maximum
Isolation Voltage	Input to Output Input to Case Output to Case	2.0KV Minimum 1.0KV Minimum 0.5KV Minimum
Remote Control		-0.5V to +12Vdc

General Parameters

Conversion Efficiency	Typical	See table
Switching Frequency	Typical	330KHz
MTBF	Bellcore TR-332 issue 6	4.41×10 ⁶ hrs @GB/25°C. (COQ48033abcd-35XXX)
OTP	Internal	110°C(Tc) ±5°C
Weight	1.0mm metal plate 3.0mm metal plate	29g 43g

Control Functions

Remote Control	Logic High Logic Low	+3.0V to +6.5V 0V to +1.0V
Input Current of Remote Control Pin		-0.5mA ~ +1.5mA

Input

Operation Voltage Range	24V Models 48V Models	+18V to +36Vdc +36V to +75Vdc
Reflected Ripple Current	L _{EXT} = 10uH	30mA rms/100mAp-p
Power ON Voltage Ranges	24V Models 48V Models	+17.0V to +18.0Vdc +34.0V to +36.0Vdc
Power OFF Voltage Ranges	24V Models 48V Models	+15.6V to +16.6Vdc +31.2V to +33.2Vdc
Off State Input Current	V _{NOM}	6mA Max
Latch-State Input Current	V _{NOM}	8mA Max
Input Capacitance	24V Models 48V Models	22.0uF Max 10.0uF Max

Output

Voltage Accuracy	Typical	±1.0%
Line Regulation	Full Input Range	±0.2%
Load Regulation	0%~100%	±0.2%
Temperature Drift	-40°C ~100°C	±0.03%/°C
Output Tolerance Band	All Conditions	±4%
Ripple & Noise (20MHz)	Peak-Peak (RMS)	3% (1%) V _O
Over Voltage Protection	V _{NOM} , 10% Load	115~130 %V _O
Output Current Limits	V _{NOM}	108%~125%
Voltage Trim	V _{NOM} , 10% Load	±10%
Input Ripple Rejection (<1KHz)	V _{NOM} , Full Load	-50dB
Step Load (2.5A/μS)	50%~75% Load	±6%Vo/500μS
Start-Up Delay Time	V _{NOM} , Full Load	20mS/250mS

TYPICAL WAVES AND CURVES

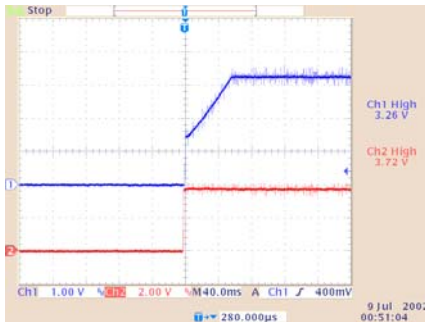

Start-up waveform of COQ48033abcd-35XXX
(V_{IN} : 50V, Load: 35A)

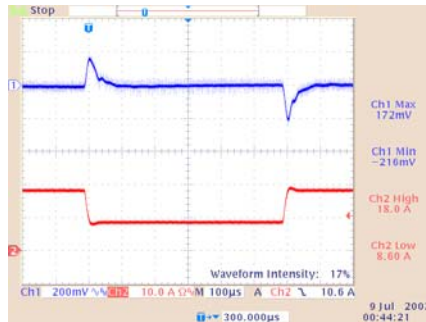

Transient response of COQ48033abcd-35XXX
(V_{IN} : 48V, Load: 18A/9A@2.5A/µs)

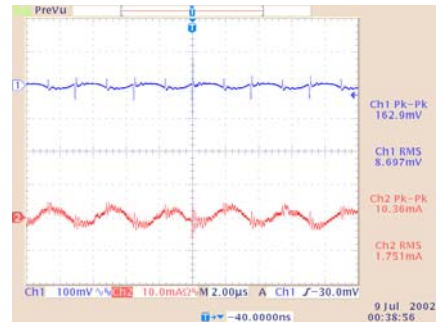

Input/Output ripples of COQ48033abcd-35XXX
(V_{IN} : 50V, Load: 35A, L_{IN} =10µH)

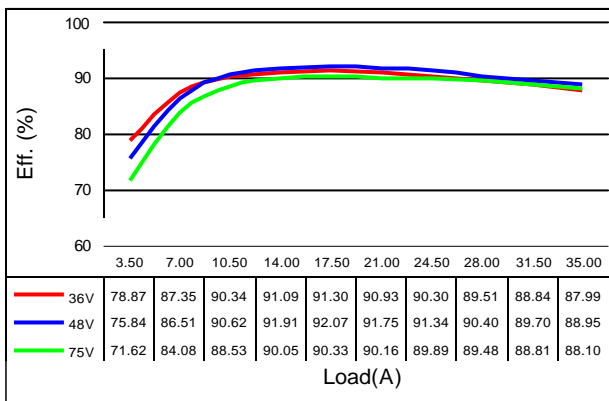

Efficiency plot of COQ48033abcA-35XXX

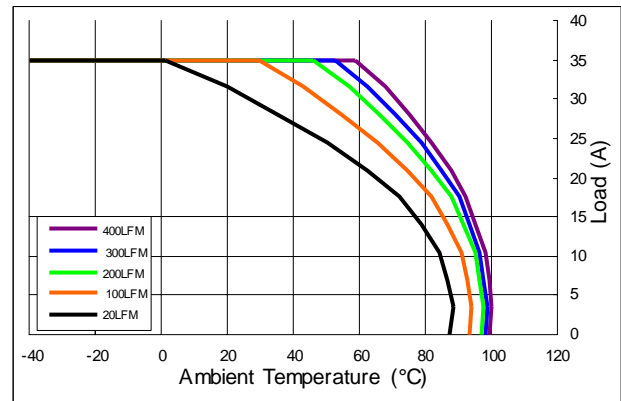

Derating curves of COQ48033abcA-35XXX for $T_c = 110^\circ\text{C}$

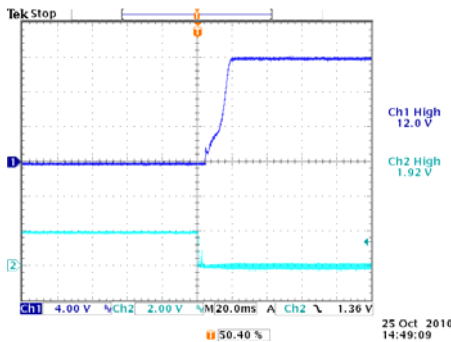

Start-up waveform of COQ48120abcd-14XXX
(V_{IN} : 48V, Load: 14A)

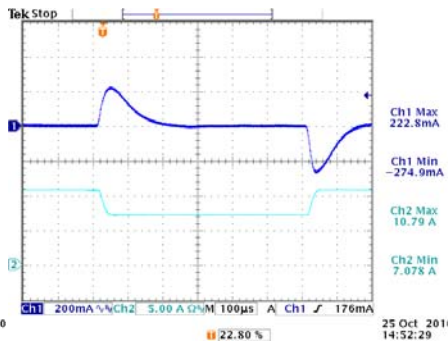

Transient response of COQ48120abcd-14XXX
(V_{IN} : 48V, Load: 10.5A/7.5A@2.5A/µs)

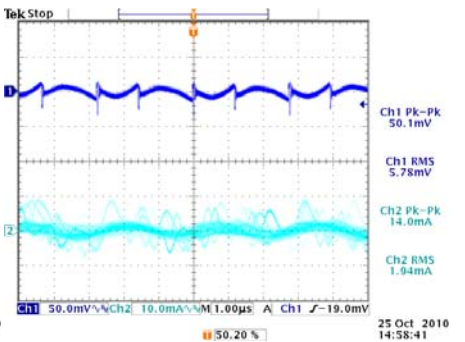

Input/Output ripples of COQ48120abcd-14XXX
(V_{IN} : 48V, Load: 14A, L_{IN} =10µH)

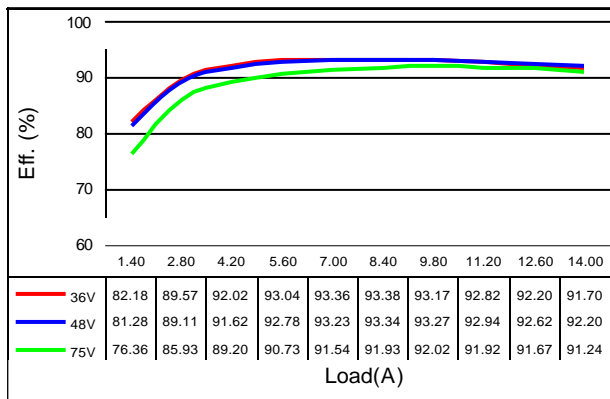

Efficiency plot of COQ48120abcA-14XXX

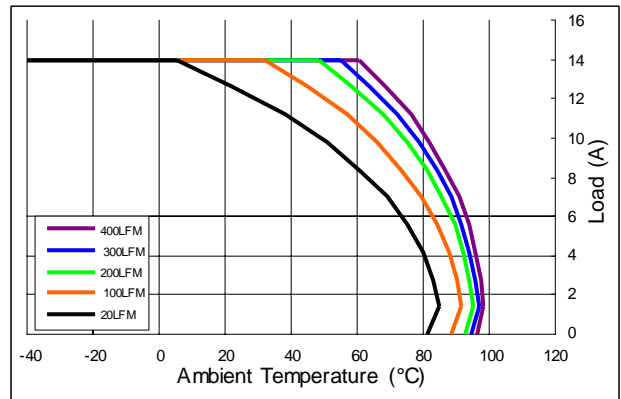

Derating curves of COQ48120abcA-14XXX for $T_c = 110^\circ\text{C}$

OPEN FRAME PACKAGE

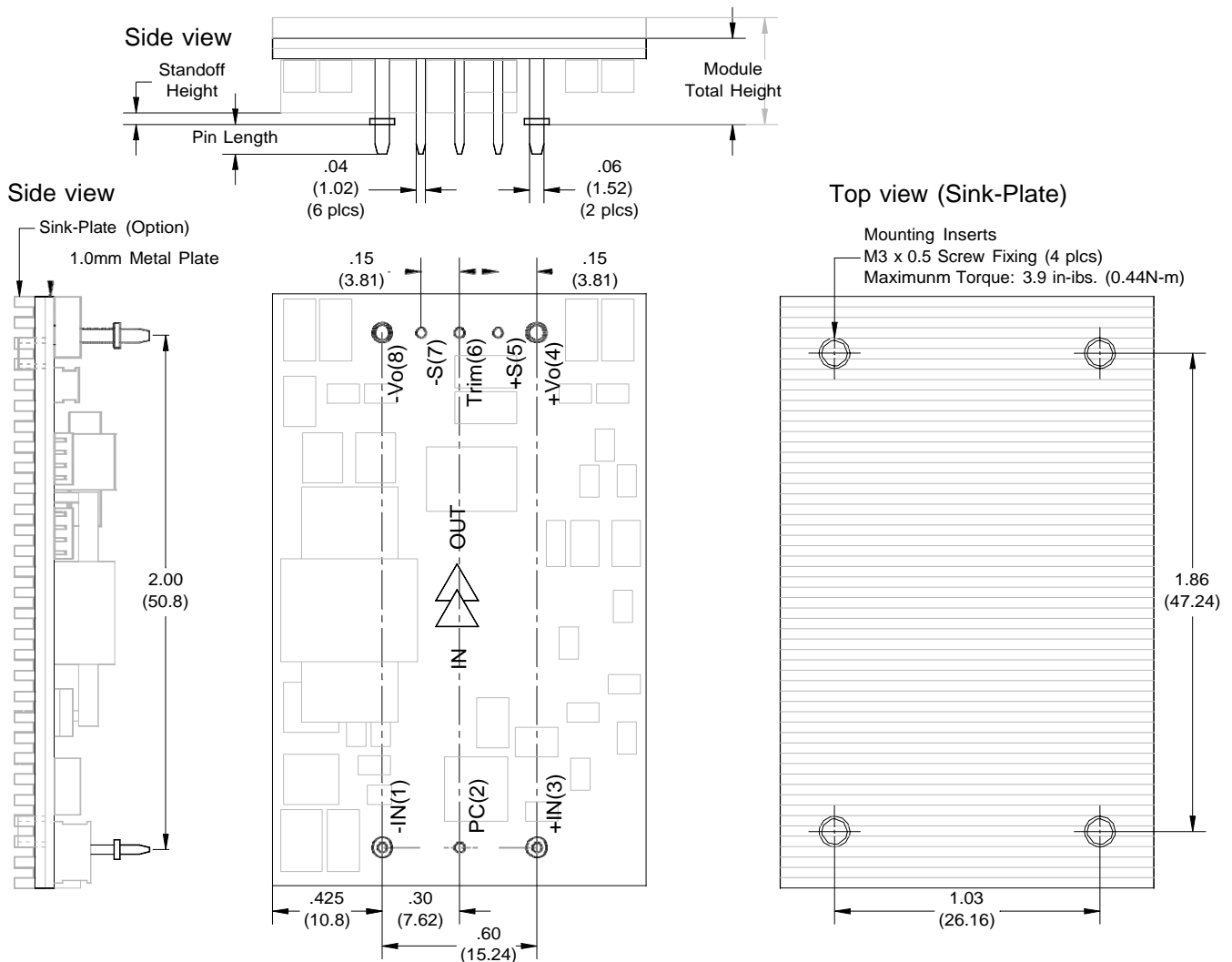

Dimensions and Pin Connections

Designation	Function Description	Pin #
-IN	Negative input	1
PC	Remote control. To turn-on and turn-off output.	2
+IN	Positive input	3
+Vo	Positive output	4
+S	Positive remote sense	5
TRIM	Output voltage adjust	6
-S	Negative remote sense	7
-Vo	Negative output	8

Dimensions: inches (mm)

Tolerances: .xx±0.02 (.x±0.5)

.xxx±0.01 (.x±0.25)

Weight: 29g / 1.0mm metal plate
43g / 3.0mm metal plate

Base plate: Aluminum alloy with anode oxide

Mounting inserts: Stainless steel

Maximum torque: 3.9 in-lb (0.44Nm)

Pin material: Copper alloy or Brass

Pin plating: Golden over Nickel

REFERENCED EMC CIRCUIT

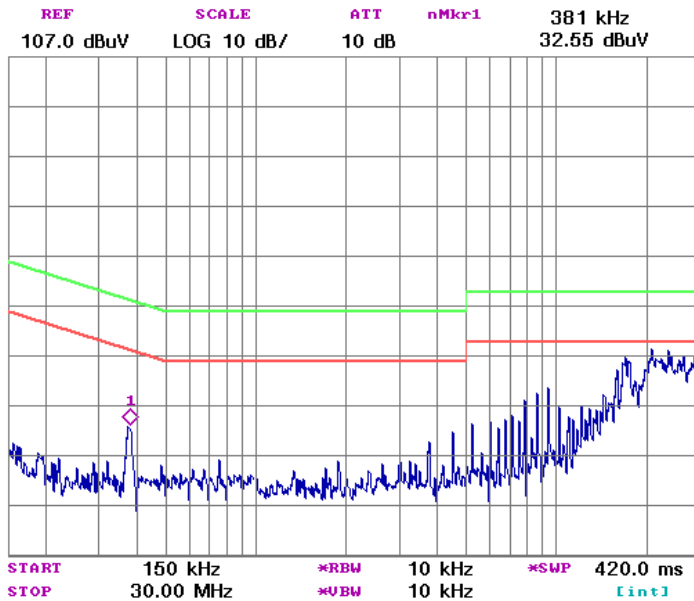

Referenced EMC Performance

The tested result shown in left-hand side is obtained by loading the power module with a resistive load only. It can be used as a design reference for customer system. However! The performance of customer's system depends on the whole system design. It should be noted that modifications on the circuit parameters and fine adjustment of the final layout affect the final EMC performance greatly.

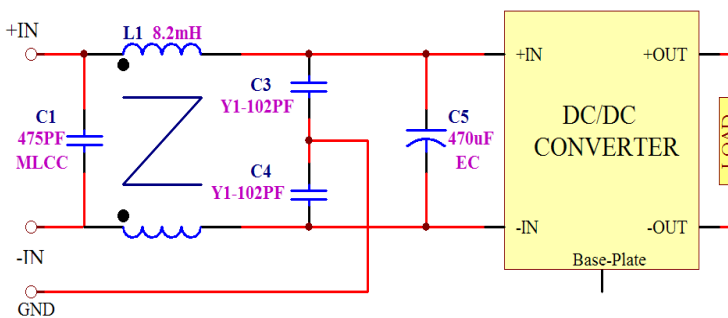

Measured conductive level of COQ48050abcd-25XXX and referenced filter circuit

Bandwidth of EMC Components

No components are ideal for infinite frequency range. The bandwidth of EMC components should be taking into consideration when designing an EMC filter circuit. To connect ceramic capacitor with electricity capacitor in parallel and connect low inductance inductor with big one could get a better bandwidth.

NOTE:

1. It is recommended that the input should be protected by fuses or other protection devices.
2. All specifications are typical at nominal input, full load and 25°C unless otherwise noted.
3. Specifications are subject to change without notice.
4. Printed or downloaded datasheets are not subject to Glary document control.
5. Product labels shown, including safety agency certificates, may vary based on the date of manufacture.
6. Information provided in this documentation is for ordering purposes only.
7. This product is not designed for use in critical life support systems, equipment used in hazardous environments, nuclear control systems or other such applications, which necessitate specific safety and regulatory standards other than the ones listed in this datasheet.

IMPORTANT

- ※ General specifications and the performances are related to standard series only, no special customer specification display here except requested items.
- ※ In order to secure effective usage of converter and the validity of Glary's service and warranty coverage, please refer to the application notes for general usage. For needs of usage beyond the application notes, please contact to Glary headquarter or our regional sales representative office for help.